

**DITHERM
LTW**

+150°C
-40°C

INOX

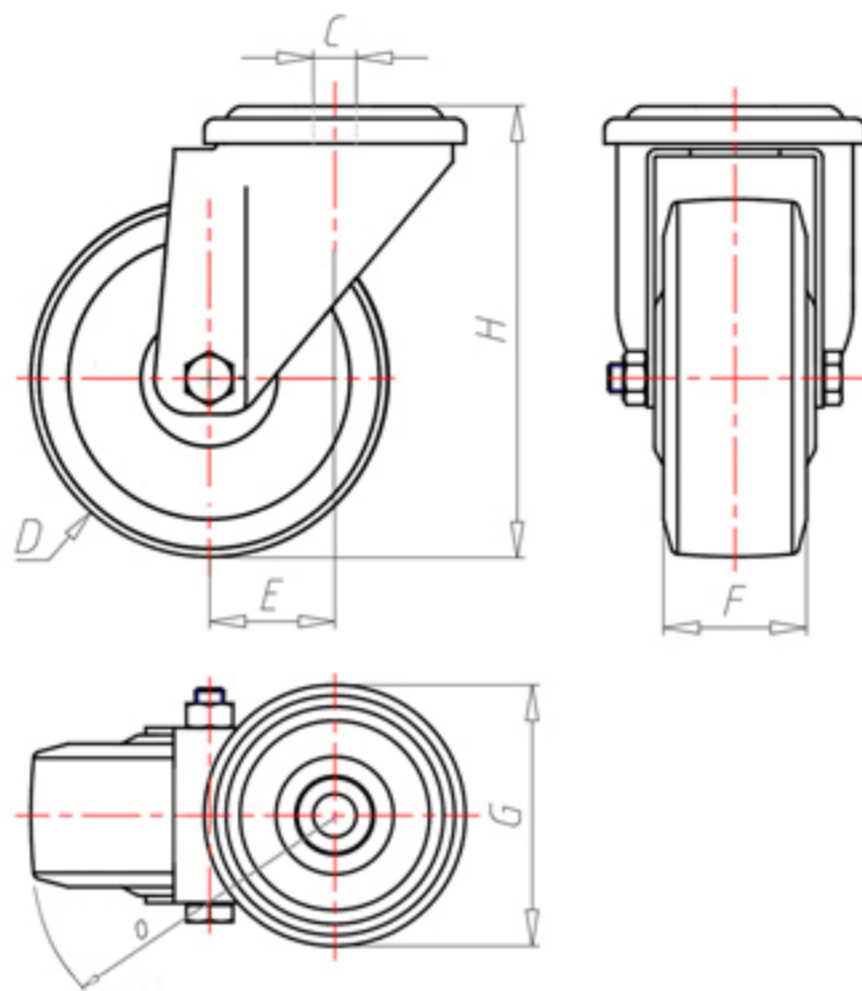

	D	150
	F	40
	H	181
	G	Ø 77
	C	Ø 12
	E	46
	O	120
	LC	250



Codice per ruota a foro passante

LPX15045



Codice per ruota con bussola rivestita in HQS

LPX15045BR



Codice per ruota con doppia boccola autolubrificante in HQS

-



Codice per ruota con doppio cuscinetto a sfere HT

-

